



**INSTALLATION INSTRUCTION AND
MAINTENANCE MANUAL
FOR SOLAR PV MODULE**

Installation Guide of PV Modules

Contents

Purpose of this guide

General

Safety precaution for installing a solar

Photovoltaic system

Product Identification

Mechanical Installation

Selecting the location

Selecting the proper support frame

Mounting Using Frame Bolt Holes

Mounting Using Clips on Long Edge of Module

Ground mount

Roof mount

Pole mount

General installation

Electrical Installation

Grid-connected electrical system

Grounding

General installation

Commission and Maintenance

Blocking diodes and bypass diodes

Testing, commissioning and troubleshooting

Maintenance

Disclaimer of Liability

Purpose of this guide

This guide contains information regarding the installation and safe handling of ECO Delta Power photovoltaic module (hereafter is referred to as “module”).

Installers must read and understand the guide before installation. Any questions, please contact our sales department for further explanations. The installer should conform to all safety precautions in the guide and local codes when installing a module.

Before installing a solar photovoltaic system, installers should become familiar with the mechanical and electrical requirement for such a system. Keep this guide in a safe place for future reference (care and maintenance) and in case of sale or disposal of the modules.

General

Installing solar photovoltaic systems may require specialized skills and knowledge. Installation should be performed only by qualified persons.

Each module comes with a permanently attached junction. Eco Delta can provide customers with fitted cables for ease of installation if desired.

Installers should assume the risk of all injury that might occur during installation, including, without limitation, the risk of electric shock.

One individual module may generate DC voltages greater than 30 volts when exposed to direct sunlight. Contact with a DC voltage of 30V or more is potentially hazardous.

Do not disconnect under load.

Photovoltaic solar modules change light energy to direct-current electrical energy. They are designed for outdoor use. Modules may be ground mounted, mounted on rooftops, vehicles or boats. Proper design of support structures is responsibility of the system designers and installers. Use of mounting holes is suggested in a following paragraph.

Do not attempt to disassemble the modules, and do not remove any attached nameplates or components from the modules.



Do not apply paint or adhesive to module top surface.
Do not use mirrors or other magnifiers to artificially concentrate sunlight on the modules. Do not expose back sheet foils directly to sunlight.



When installing the system, abide with all local, regional and national statutory regulations. Obtain a building permit where necessary.

Safety precaution for installing a solar photovoltaic system

Solar modules produce electrical energy when light shines on their front surface. The DC voltage may exceed 30V. If modules are connected in series, the total voltage is equal to the sum of the individual module voltages. If modules are connected in parallel, the total current is equal to the sum of individual module currents.

Keep children well away from the system while transporting and installing mechanical and electrical components.

Completely cover the module with an opaque material during installation to keep electricity from being generated.

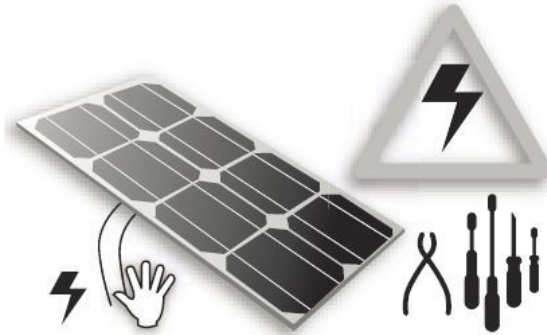

Do not wear metallic rings, watchbands, ear, nose, lip rings or other metallic devices while installing or troubleshooting photovoltaic systems.

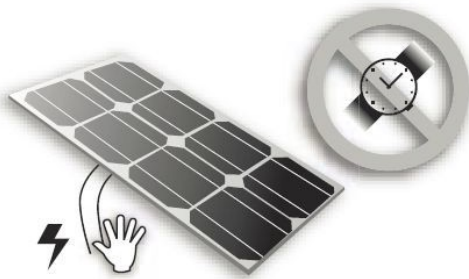

Use only insulated tools that are approved for working on electrical installations. Abide with the safety regulations for all other components used in the system, including wiring and cables, connectors, charging regulators, inverters, storage batteries and rechargeable batteries, etc.

Use only equipment, connectors, wiring and support frames suitable for a solar electric system. Always use the same type of module within a particular photovoltaic system.

The electrical characteristics are within ± 10 percent of the indicated values of I_{sc} , V_{oc} , and P_{max} under standard test conditions (irradiance of $100\text{mW}/\text{cm}^2$, AM 1.5 spectrums, and a cell temperature of 25°C (77°F))

Under normal outdoor conditions the module will produce current and voltages that are different than those listed in the data sheet. Data sheet values are values expected at standard test conditions. Accordingly, during system design, values of short-circuit current and open-circuit voltages should be multiplied by a factor of 1.25 when determining component voltage ratings, conductor ampacity, fuse ratings and size of controls connected to the modules or system output.



Product identification

Each module has three labels on its rear side providing the following information:
Nameplate: describes the product type; rated power, rated current, rated voltage, open circuit voltage, short circuit current, all as measured under standard test conditions; weight, dimension etc.; the maximum system voltage 1500 volts DC and is shown on the nameplate. Maximum fuse rating is also shown.

“Pass”: describe inspection date and security class.

Bar code: each individual module has a unique serial number. The serial number has 13 digits. There is only one bar code on module. It is permanently attached to the interior of the module visible when viewing from the front of the module. This bar code is inserted at the beginning of laminating.

Do not remove any label.

If the label is removed, the product warranty will no longer be honored by ECO.

Mechanical Installation

Selecting the location

Select a suitable location for installing the modules.

The modules should be facing south in northern latitudes and north in southern latitudes.

For detailed information on the best elevation tilt angle for the installation, refer to standard solar photovoltaic installation guides or a reputable solar installer or systems integrator.

The module should not be shaded at any time of the day.

Do not use module near equipment or in locations where flammable gases can be generated or collected.

Selecting the proper support frame

Always observe the instructions and safety precautions included with the support frames to be used with the modules.

Do not attempt to drill holes in the glass surface of the modules. To do so will void the warranty.

Do not drill additional mounting holes in the frame of the modules. Doing so will void the warranty.

Modules must be securely attached to the mounting structure using four mounting points for normal installation.

Mounting with Clamps

We have tested its modules with a number of clamps from different manufacturers and recommends the use of clamps which have an EPDM or similar insulating washer, fixing bolt of at

least M6. The clamp must overlap the module frame by at least 0.28 in but no more than 0.39 in.

- Use at minimum 4 clamps to fix modules on the mounting rails.
- Modules clamps should not come into contact with the front glass and must not deform the frame.
- Be sure to avoid shadowing effects from the module clamps.
- The module frame is not to be modified under any circumstances.
- When choosing this type of clamp-mounting method, use at least four clamps on each module, two clamps should be attached on each long sides of the module (for portrait orientation) and each short sides of the module (for landscape orientation). Depending on local wind and snow loads, additional clamps may be required to ensure that modules can bear the load.
- Applied torque should refer to mechanical design standard according to the bolt customer is using:

M6 ---- 70 lbf*in;

M8---- 140 lbf*in.

The modules negative design loading 2400Pa, with 1.5 times safety factor(wind load/snow load).

Load \leq 3600Pa(Using 4 clamps)Load \leq 3600Pa(Using 4 clamps)

	NO.	L*W(mm)
	1	1755*1038
	2	2094*1038

Notes: L is the length of PV module, W is the wide of module ,and the black shaded part is the installation range.

End Clamp installation(40mm optional)

Middle Clamp installation

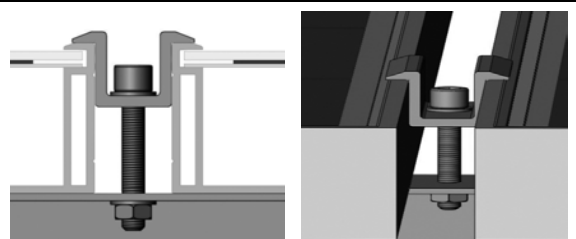
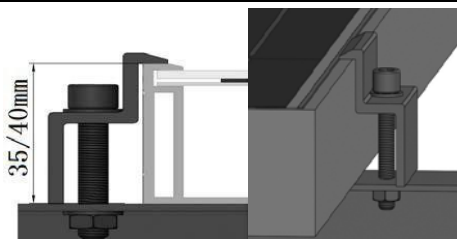

SPV module installed with clamp fitting method.

Mounting with Bolts

The frame of each module has 14 x 9mm mounting holes, ideally placed to optimize the load handling capability, to secure the modules to supporting structure.

- To maximize mounting longevity, our Solar strongly recommends using corrosion proof (stainless steel) fixings.
- Secure the module in each fixing location with an M8mm bolt and a flat washer, spring washer and nut as shown in Figure 1 and tighten to a torque of 180 in lb.

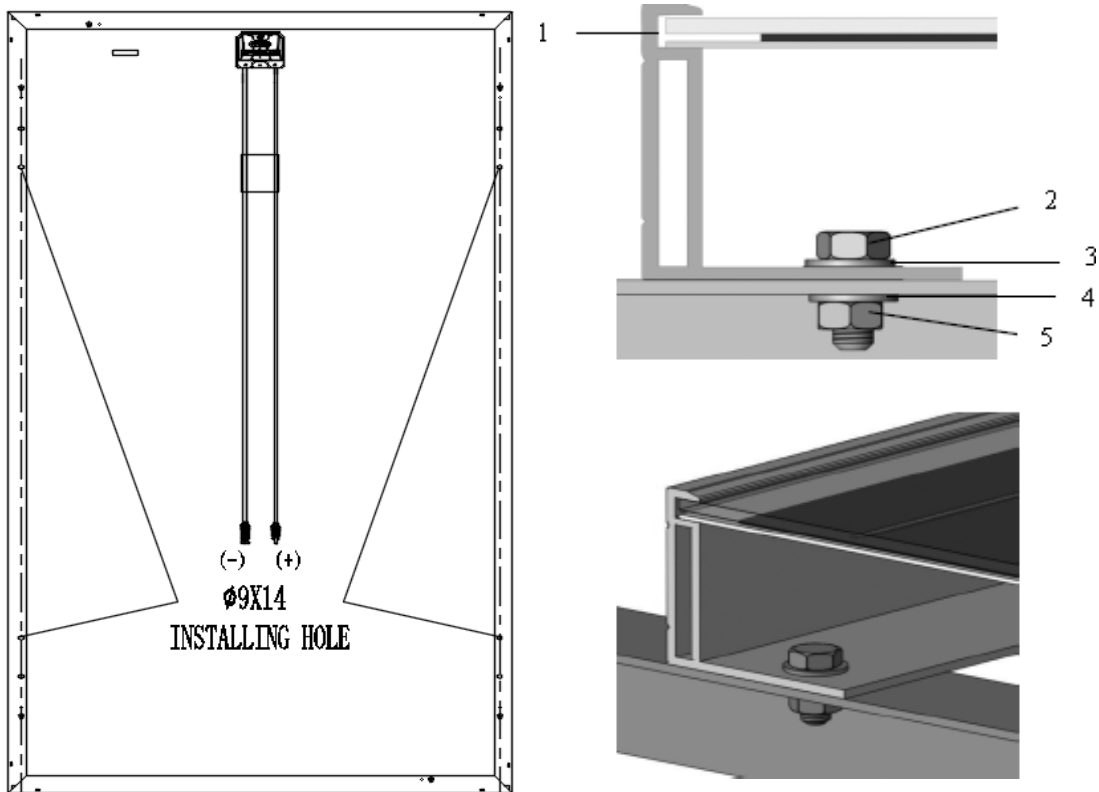
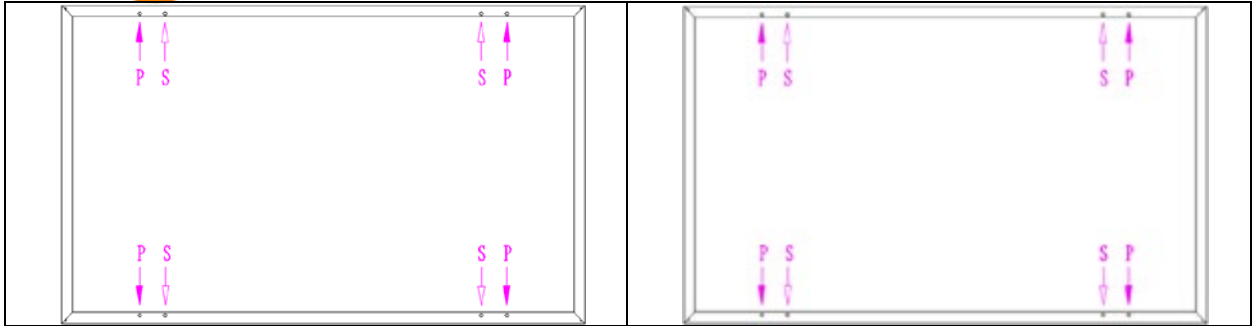

Figure1. SPV module installed with

Bolt fitting method

- 1 Aluminum Frame
- 2 M8Stainless bolt
- 3 Flat Stainless Washer
- 4 Spring Stainless Washe
- 5 HEX Stainless Nut

L≤1775mm	1775mm≤L≤2115mm
Load≤3600Pa	Load≤3600Pa a
Using 4 installation holes with S holes	Using 4 installation holes with S holes



Mechanical Installation

The support module mounting structure must be made of durable, corrosion-resistant and UV-resistant material.

Groundmount

Select the height of the mounting system to prevent the lowest edge of the module from being covered by snow for a long time in winter in areas that experience heavy snowfalls. In addition, assure the lowest portion of the module is placed high enough so that it is not shaded by plants or trees or damaged by sand and stone driven by wind.

Roof mount

When installing a module on a roof or building, ensure that it is securely fastened and cannot fall as a result of wind or snow loads.

Provide adequate ventilation under a module for cooling (10cm minimum air space between module and mounting surface).

When installing module on a roof, ensure that the roof construction is suitable. In addition, any roof penetration required to mount the module must be properly sealed to prevent leaks.

In some cases, a special support frame may be necessary.

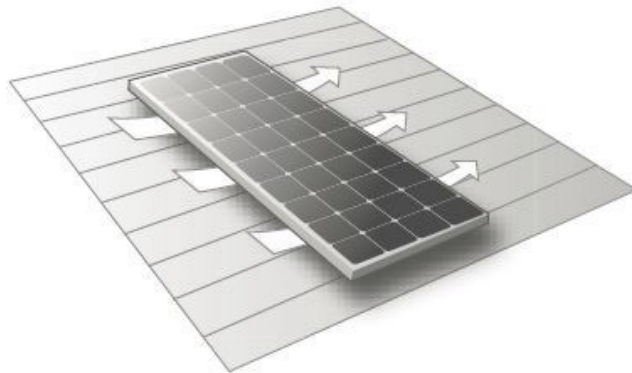

The roof installation of solar modules may affect the fireproofing of the house construction.

The modules are rated fire Class C, and are suitable for mounting over a class A roof. Do not install modules on a roof or building during strong winds in case of accidents.

Mechanical Installation

Pole mount

When installing a module on a pole, choose a pole and module mounting structure that will withstand anticipated winds for the area.

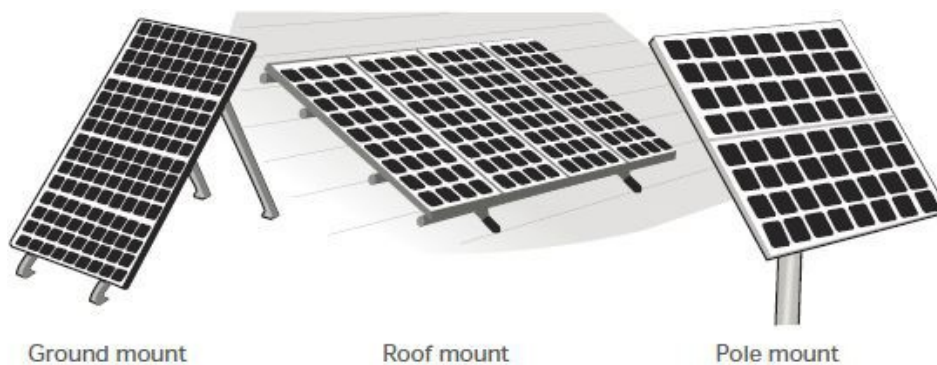

General installation

Module mounting must use the pre-drilled mounting holes in the frame.

The most common mounting is achieved by mounting the module using the four symmetry points close to the inner side on module frames.

If excessive wind or snow loads are expected, all eight mounting holes must be used

Do not lift the module by grasping the module's junction box or electrical leads.

Do not stand or step on module.

Do not drop module or allow objects to fall on module.

To avoid glass breakage, do not place any heavy objects on the module.

Do not set the module down hard on any surface.

Inappropriate transport and installation may break module.

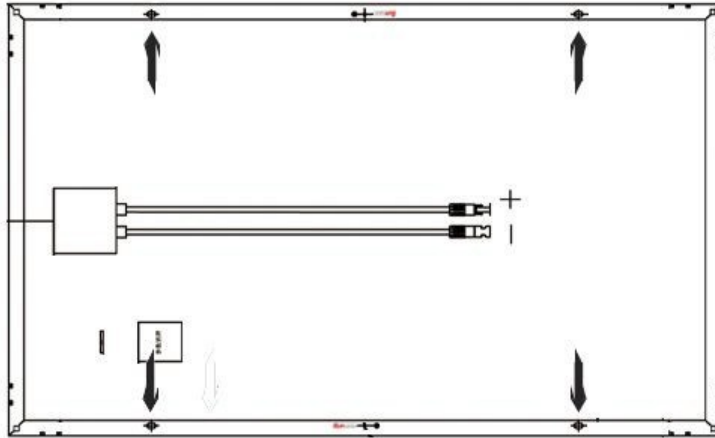

Electrical Installation

This guide describes some of the most important typical uses as representative examples.

Grid-connected electrical system

The DC electrical energy generated by photovoltaic systems may also be converted to AC and connected to a utility grid system. As local utilities' policies on connecting renewable energy systems to their grids vary from region to region.

Consult a qualified system designer or integrator to design such a system. Permits are normally required for installing such a system and the utility must formally approve and inspect such a system before it can be accepted.

Grounding

The module frame must be properly grounded. The grounding wire must be properly fastened to the module frame to assure good electrical contact. Use the recommended type, or an equivalent, connector for this wire.

If the support frame is made of metal, the surface of the frame must be electroplated and have excellent conductivity.

We recommend the lay-in lug (Cat. No. GBL4-DBT is recommended by Eco Delta) when grounding. First strip 16mm insulating jacket from the end of the ground wire carefully to avoid nicking or cutting conductors, insert the wire to the feet of the lug (see the picture), and screw down the slotted screw. Be careful not to damage the wire core. And then tighten up the screw.



Insert ground wire here 

Electrical Installation

Next, assemble the recommended ILSCO grounding lug to the aluminum frame using stainless steel M3 or M5 screw and hardware as shown below. Note: there are two different size grounding holes, the smaller of which is being phased out.

Further, buildup of hardware for mounting the grounding lug are the same—except for the M3 screw, an added flat washer is mounted directly under the M3 screw head. The star washer is fitted directly under the grounding lug and makes electrical contact by penetrating the anodized coating of the aluminum frame; the screw assembly is further fitted with a flat washer, then a split lock washer and finally a nut to secure the entire assembly, as shown. Recommended torque of M3 or M5 screw assembly is 0.8NM or 1.5NM.

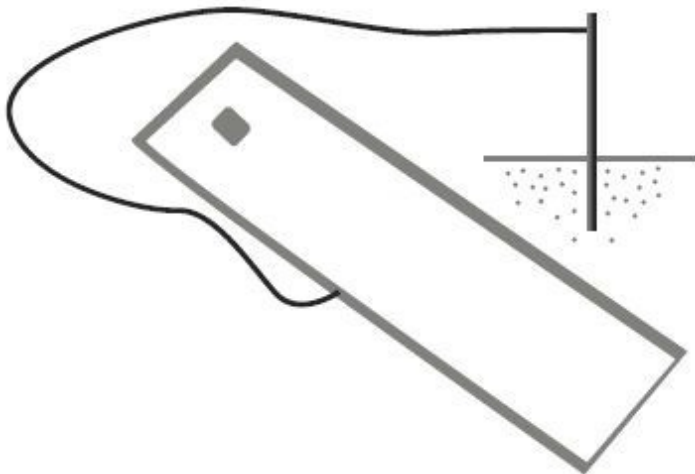

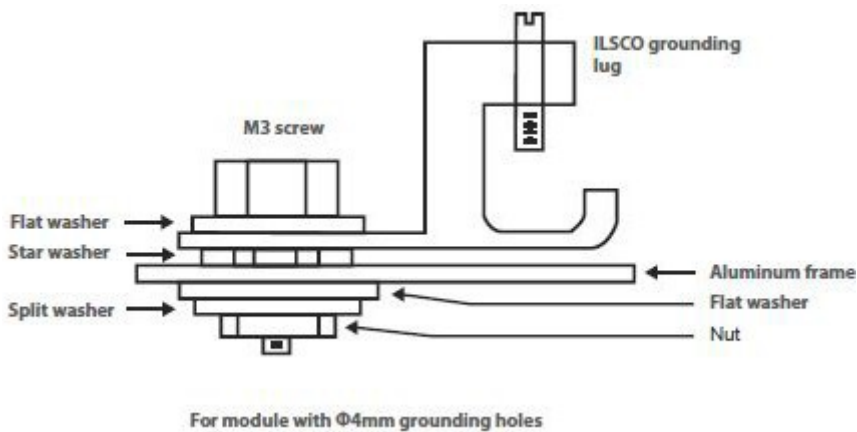
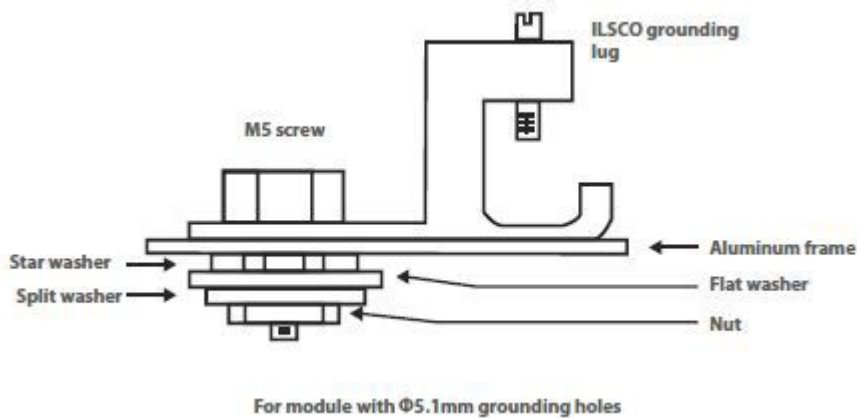

Electrical Installation

General installation

Do not use modules of different configurations in the same system. The max. number of module (N) = $V_{\text{max system}} / [V_{\text{oc(atSTC)}}]$.

Several modules are connected in series and then in parallel to form a PV array, especially for application with a high operation voltage. If modules are connected in series, the total voltage is equal to the sum of individual voltages.

For applications requiring high currents, several photovoltaic modules can be connected in parallel; the total current is equal to the sum of individual currents.

Module is supplied with connectors to use for system electrical connections.

Consult rated local wiring regulations to determine system wire size, type, and temperature.

The cross section area of cable and the capacity of connector must be selected to suit the maximum system short circuit current (Recommended cross section area of cable is 4mm^2 for a single module and rated current of a connector is larger than 20A), otherwise the cable and connector will be overheated under large current.

Please note that the upper limit temperature of cable is $\geq 85^{\circ}\text{C}$, and the connector is $\geq 105^{\circ}\text{C}$.

The junction box has a breather port. The breather port must be mounted facing down and can not be exposed to rain. Therefore, the junction box must be on the higher side of the module when it is mounted.

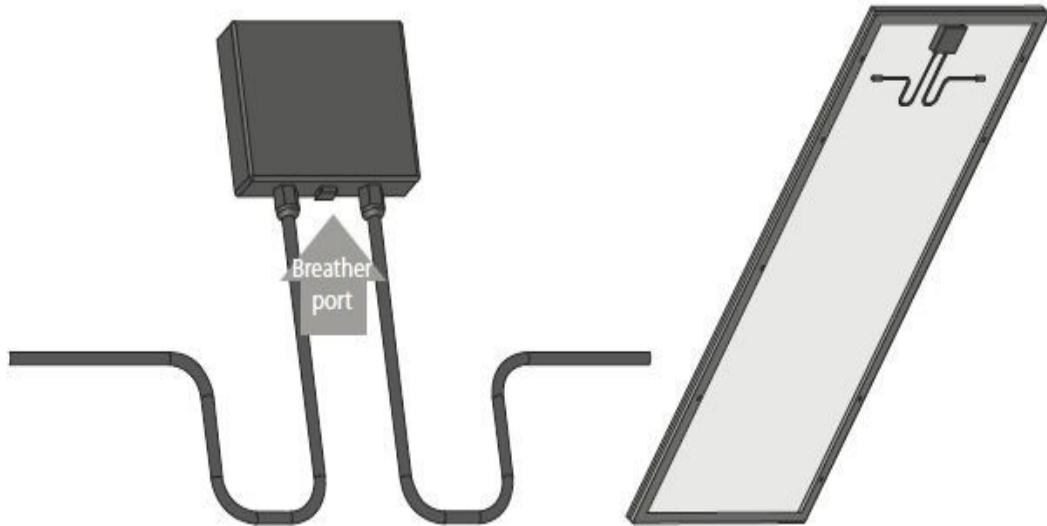

Commission and Maintenance

First, check all wiring connections to make sure it is not open-circuit or is not connection well.

Check the open-circuit voltage of each module:

Fully cover the modules with an opaque material.

Disconnect the wiring at both terminals of the modules.

Remove the opaque material from the module to be checked and measure the open-circuit voltage at its terminals.

If the measured voltage is only half of the rated, this indicates a defective bypass diode. Refer to 'Testing and replacing bypass diodes'.

In the case of not very low irradiance, if the voltage across the terminals differs from the rated value by more than 5 percent, this indicates a bad electrical connection.

Maintenance

Eco Delta recommends the following maintenance in order to ensure optimum performance of the module:

Clean the glass surface of the module as necessary. Always use water and a soft sponge or cloth for cleaning. A mild, non-abrasive cleaning agent can be used to remove stubborn dirt.

Check the electrical and mechanical connections every six months to verify that they are clean, secure and undamaged.

If any problem arises, have them investigated by a competent specialist. Attention, observe the maintenance instructions for all components used in the system, such as support frames, charging regulators, inverters, batteries etc.

Disclaimer of liability

Because the use of this manual and the conditions or methods of installation, operation, use and maintenance of photovoltaic (PV) product are beyond Eco Delta's control, Eco Delta does not accept responsibility and expressly disclaims liability for loss, damage, or expense arising out of or in any way connected with such installation, operation, use or maintenance.

No responsibility is assumed by Eco Delta for any infringement of patents or other rights of third parties, which may result from use of the PV product. No license is granted by implication or otherwise under any patent or patent rights.

The information in this manual is based on Eco Delta's knowledge and experience and is believed to be reliable; but such information including product specification (without limitations) and suggestions do not constitute a warranty, expresses or implied. Eco Delta reserve the right to change the manual, the PV produce, the specifications, or product information sheets without prior notice.

ECO DELTA POWER

Headquarters Add: No.65 Dacang Road, Zhonglou, Changzhou, China

Website: www.ecodeltapower.com

Email: info@ecodeltapower.com

ECO SAKURA ENERGY PTY LTD

EMAIL: info@ecosakura.com.au

ABN: 68 638 566 471

Web: <http://www.ecosakura.com.au/>

Tel: 1300 823 028